

KOMATSU

PW148-11



Hydraulic wheeled excavator

Engine power
110 kW / 148 HP @ 2000 rpm

Operating weight
13865 - 16100 kg

Bucket capacity
max. 0.86 m³

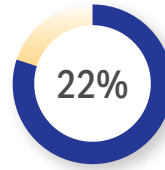

More powerful
Higher engine power:
+20 kW vs previous model



Save time
Higher uphill travel speed:
+30% vs previous model



Save costs
Reduced fuel consumption:
-5% vs previous model



Engine power
110 kW / 148 HP @ 2000 rpm

Operating weight
13865 - 16100 kg

Bucket capacity
max. 0.86 m³

High versatility, low fuel consumption and safe performance in tight spaces

Powerful and environmentally friendly

- EU Stage V engine
- Adjustable idle shutdown
- Komatsu fuel-saving technology
- Excellent travel performance
- High lifting capacity

Total versatility

- Compact design with short tail swing radius
- Ideal for a wide range of applications
- Additional hydraulic circuit
- Komatsu Integrated Attachment Control (KIAC) (option)
- A wide choice of options

First-class operator comfort

- Air-suspended operator seat with integrated joystick consoles
- Premium air-suspended operator seat (option)
- Boom suspension system (ECSS) (option)
- KomVision surround view system
- Widescreen monitor
- Joystick steering system (option)

State-of-the-art controls

- Proportional controls for attachments
- Improved, ergonomic switches
- 6 working modes

Easy maintenance

- Ground level service access
- Centralised greasing system
- User-friendly location of the electric refuelling pump
- Simple access to the AdBlue® tank

Komtrax

- Komatsu Wireless Monitoring System
- 4G mobile communications
- Increased operational data and fuel savings
- Integrated communication antenna



A maintenance program
for Komatsu customers



Higher productivity

Along with its compact size, the PW148-11 features an unrivalled lifting performance. The combination of power, weight distribution, convenient dimensions and complete control makes it the top choice for heavy-duty lifting applications, simple excavating tasks in narrow alleys, and for road and sewer construction sites.

Komatsu fuel-saving technology

Fuel consumption on the PW148-11 is lower by up to 5% vs previous model. Engine management is enhanced. The variable speed matching of the engine and hydraulic pumps guarantee efficiency and precision during single and combined movements. A viscous clutch enables variable cooling fan speed to further reduce fuel consumption.

Adjustable idle shutdown

The Komatsu auto idle shutdown automatically turns off the engine after it idles for a set period of time. This feature can easily be programmed from 5 to 60 minutes, to reduce unnecessary fuel consumption and exhaust emissions, and to lower operating costs. An Eco-gauge and the Eco guidance tips on the cab monitor further encourage efficient operations.

Powerful and environmentally friendly

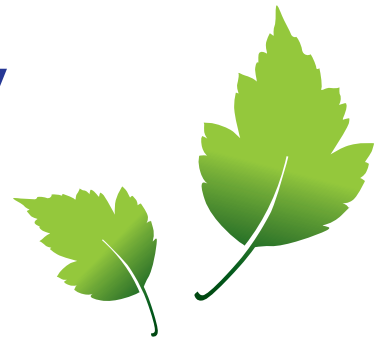

Komatsu EU Stage V

The Komatsu EU Stage V engine is productive, dependable and efficient. With ultra-low emissions, it provides a lower environmental impact and a superior performance to help reduce operating costs and lets the operator work in complete peace of mind.

Heavy-duty aftertreatment

The aftertreatment system combines a Komatsu Diesel Particulate Filter (KDPF) and Selective Catalytic Reduction (SCR). The SCR injects the correct amount of AdBlue® into the system at the proper rate to break down NOx into water (H₂O) and non-toxic nitrogen gas (N₂).

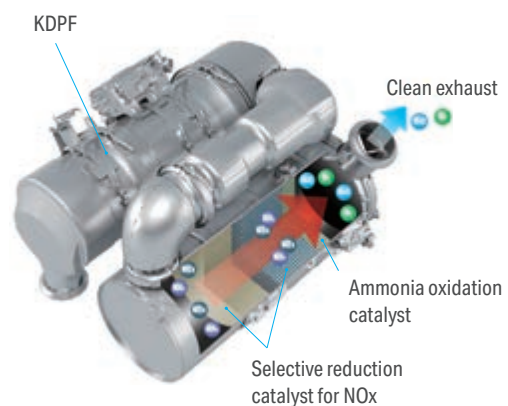

High-Pressure Common Rail (HPCR)

To achieve complete fuel burn and lower exhaust emissions, the heavy-duty High-Pressure Common Rail fuel injection system is computer controlled to deliver a precise quantity of pressurised fuel into the redesigned engine combustion chamber by multiple injections.

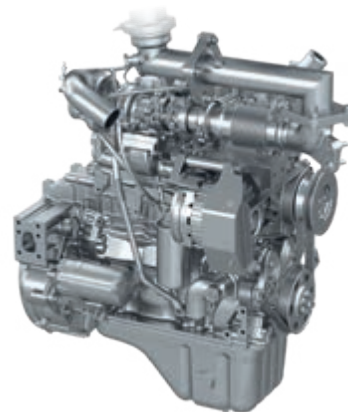

Eco-gauge, Eco guidance and fuel consumption gauge

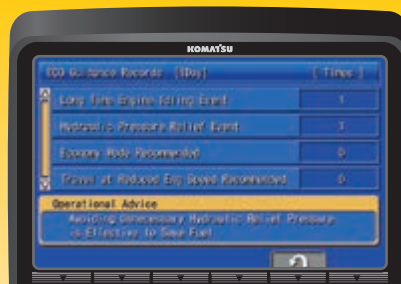

ECO guidance record

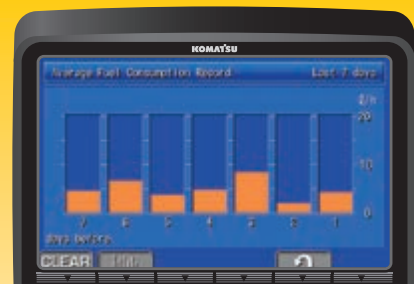

Fuel consumption history

Compact design

The PW148-11 is perfect for confined work sites, with a compact design and a tail swing radius of only 1.85 m. In urbanised areas, but also on road or sewer construction sites where space is limited, the PW148-11 is a high output performer and offers more safety and less worries for the operator.

Additional hydraulic circuit

To allow the use of many attachments, such as buckets, breakers or clamshell buckets, an additional hydraulic circuit controlled by a sliding joystick button is standard on the PW148-11. To further increase versatility and flexibility, a second optional auxiliary circuit and an optional hydraulic quick-coupler actuation are also available. In combination with the Komatsu Integrated Attachment Control (KIAC), changing and operating different attachments becomes child's play.



Total versatility



Total versatility



Quick-couplers

Lehnhoff quick-couplers – mechanical, hydraulic or fully hydraulic – are available for factory installation. They can turn an excavator into a multi-functional tool carrier for any type of attachment. All quick-couplers offer high functional safety thanks to their sealed locking mechanisms and hydraulics. The Lehmatic Safety Control (LSC) assistant system is integrated into the machine's monitor and gives the operator full control of the Lehnhoff quick coupler's locking status.



Automatic digging brake

This new optional digging brake automatically activates the service brake and oscillation lock when the machine stops, and it releases them when the machine accelerates again. The operator can fully focus on the job with no need to step on the brake.



Trailer hitch

For increased versatility, the PW148-11 can be equipped with either a car ball type hitch, an agricultural ball type hitch, or a truck type automatic hitch, for trailers up to 7,5 tonnes with an overrun brake. All necessary electric and hydraulic hook-ups are provided, including two auxiliary undercarriage circuits for dumping or tail-gate operation. These trailer functions can be operated from the cab joysticks.

Boom suspension system (ECSS)

An optional electrical controlled suspension system (ECSS) for the boom provides a significant increase in comfort when traveling over bumps.

Standard or wide axles

No matter the job, with a small turning radius and excellent traction the axles are built for a maximum performance. For even better stability a 2750 mm wide axle is available. If more traction is needed, an optional 35% differential lock helps to get over rough terrain. To keep the machine cleaner, robust fenders are also available as option.





Komatsu Integrated Attachment Control (KIAC)



Adjustable oil flow

Komatsu Integrated Attachment Control (KIAC) (option)

For fast and safe tool changes without leaving the cab, the settings for oil flow and pressure of up to 15 hydraulic attachments are available as presets directly on the monitor panel. Komatsu Integrated Attachment Control (KIAC) includes adjustments for the first and second (optional) hydraulic circuits. Selecting the breaker mode automatically cuts all pressure in the return line.



Increased comfort

The SpaceCab™ provides an ergonomic and quiet work environment, with an outstanding view of the jobsite. ROPS certified, it was specifically designed by Komatsu for hydraulic excavators, with a reinforced pipe-structured framework set up on viscous damper mounts for low vibration levels. The standard telescopic steering wheel is comfortably adjustable in height and reach.

Improved operator convenience

With increased in-cab storage space, an auxiliary input (MP3 jack) and 12 V and 24 V power supply, the cab offers maximum convenience. The automatic air conditioner allows the operator to easily and precisely set the cab's atmosphere.

Premium comfort seat (option)

The premium comfort seat comes with suspended joystick consoles, top quality cushioning, auto weight adjustment, pneumatic lumbar support and a climate control system for perfect seat temperature adjustment.

Low-noise design

Komatsu wheeled excavators have very low external noise levels and are especially well-suited for work in confined spaces or urban areas. The optimal usage of sound insulation and of sound absorbing materials helps to make noise levels inside the cab comparable to those of an executive car.



Premium comfort seat (option)



Exceptionally good overview of the surroundings from the cab

First-class comfort

Easy operation

The Komatsu PW148-11 features an operational concept that puts full control of the machine right at the operator's fingertips. Different camera views, undercarriage attachments and the manual axle lock can all be actuated by buttons on top of the operational levers. Without removing the hand from the joystick, the operator can switch from boom operation to undercarriage control for complete and precise control over the parallel dozer blade.



Ergonomically designed switches that light up for safe and easy night operation



Ergonomic joysticks with proportional controls

Proportional controls

The ergonomic joysticks with proportional controls were specially redesigned and developed for working with a wheeled excavator. They have horizontal sliders for the first and second (optional) hydraulic circuits and offer safe and precise operation of attachments such as ditch cleaning buckets, sorting grapples, clamshell buckets, tilt rotators and of many other hydraulic attachments that require very fine control.

6 working modes

The PW148-11 delivers the required power with the lowest fuel consumption. 6 working modes are available: Power, Lifting/Fine Operation, Breaker, Economy, Attachment Power and Attachment Economy. The operator can ideally balance the Economy mode between power and economy to match the work at hand.



Joystick steering

With the optional joystick steering the operator can precisely fingertip control the machine on any jobsite. This allows the easy combined operation of driving and working with the attachment simultaneously.



An evolutionary interface

Helpful information is now easier than ever to find and understand with the upgraded monitor interface. An optimal main screen for the ongoing work can be selected simply by pressing the F6 key.

Lower operating costs

Komatsu ICT contributes to the reduction of operating costs by assisting to comfortably and efficiently manage operations. It raises the level of customer satisfaction and the competitive edge of our products.

Widescreen monitor

Installed with a choice of 26 languages, the widescreen monitor with simple switches and multifunction keys gives fingertip access to a large range of functions and operating info.

Equipped with universal piping for attachments such as breakers, the conversion to a low-pressure mode requires only a push of the breaker mode switch on the monitor.



Quick view on the operation logs



With KomVision, various camera view options help to maintain a constant bird's eye view from above the machine



Operator identification function

Information & communication technology



Knowledge

You get quick answers to basic and critical questions about your machines – what they're doing, when they did it, where they're located, how they can be used more efficiently and when they need to be serviced. Performance data is relayed by wireless communication technology (satellite, GPRS or 4G depending on model) from the machine to a computer and to the local Komatsu distributor – who's readily available for expert analysis and feedback.

Convenience

Komtrax enables convenient fleet management on the web, wherever you are. Data is analysed and packaged specifically for effortless and intuitive viewing in maps, lists, graphs and charts. You can foresee eventual maintenance issues and required spare parts, and troubleshoot a problem before Komatsu technicians arrive on site.



The way to higher productivity

Komtrax uses the latest wireless monitoring technology. Compatible on PC, smartphone or tablet, it delivers insightful and cost saving information about your fleet and equipment, and offers a wealth of information to facilitate peak machine performance. By creating a tightly integrated web of support it allows proactive and preventive maintenance and helps to efficiently run a business.

Power

The detailed information that Komtrax puts at your fingertips 24 hours a day, 7 days a week gives the power to make better daily and long-term strategic decisions – at no extra cost. Problems can be anticipated, maintenance schedules customised, downtime minimised and machines kept where they belong: working on the jobsite.



Optimal jobsite safety

Safety features on the Komatsu PW148-11 comply with the latest industry standards and work in synergy to minimise risks to people in and around the machine. A neutral detection system for travel and work equipment levers increase jobsite safety, along with a seat belt caution indicator and an audible travel alarm. Highly durable anti-slip plates – with additional high friction covering – maintain long term traction performance.

Safe operation in confined areas

The compact tail design minimises the risks of rear impact and lets the operator concentrate fully on the job. The machine can work safely in narrow spaces or in obstructed areas.

Safety first



KomVision cameras



Handrails and anti-slip plates



KomVision

With a series of high definition networked cameras fitted on the machine, KomVision provides a crystal clear, real-time bird's eye view of the immediate surroundings on the widescreen cab monitor. The operator can quickly and easily check the machine's vicinity prior to making any movement, and focus on the work at hand even in low light conditions.

Safe maintenance

Thermal guards around high temperature areas of the engine, protected fan belt and pulleys, a pump/engine partition that prevents hydraulic oil from spraying onto the engine, and exceptionally sturdy handrails: in Komatsu tradition, the highest safety level is provided for a fast and smooth maintenance.



Easy maintenance

Simple and convenient service

The large doors and engine hood give convenient access to all daily service points. Filters are centralised and required service intervals are longer to keep machine downtime to a minimum.

Remote greasing bar

The PW148-11 features a centralised system that facilitates the regular greasing of the boom. An optional fully automatic greasing system can handle the regular and proper greasing of the complete machine – prolonging the lifetime and increasing the resale value of the excavator.

Electric refuelling pump

Standard equipment on all PW148-11 includes an automatic shut-off fuelling pump that allows easy refuelling from a barrel.

Easy radiator access

Thanks to a side-by-side cooler arrangement, the aftercooler and hydraulic oil radiator can be cleaned easily and repaired individually in case of damage.

Komatsu Care

Komatsu Care is a maintenance program that comes as standard with your new Komatsu machine. It covers factory-scheduled maintenance, performed with Komatsu Genuine parts by Komatsu-trained technicians. It also offers extended coverage of the Komatsu Diesel Particulate Filter (KDPF) and of the Selective Catalytic Reduction (SCR). Please contact your local Komatsu distributor for terms and conditions.

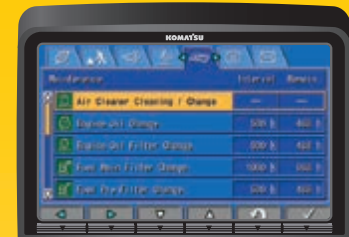

Basic maintenance screen

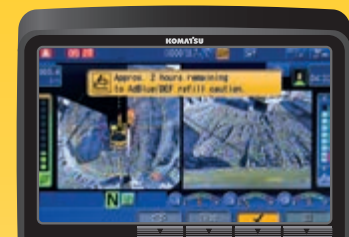

AdBlue® level and refill guidance



Simple access to the AdBlue® tank



Automatic greasing system (option)



Specifications

PW148-11E0

Engine

Model	Komatsu SAA4D107E-5
Type	Common rail direct injection, water-cooled, emissionised, turbocharged, after-cooled diesel
Engine power	
at rated engine speed	2000 rpm
ISO 14396	110 kW / 148 HP
ISO 9249 (net engine power)	110 kW / 148 HP
No. of cylinders	4
Bore × stroke	107 × 124 mm
Displacement	4.5 l
Air filter type	Double element type with monitor panel dust indicator and auto dust evacuator
Cooling	Suction type cooling fan with radiator fly screen
Fuel	Diesel fuel, conforming to EN590 Class 2/ Grade D. Paraffinic fuel capability (HVO, GTL, BTL), conforming to EN 15940:2016

Hydraulic system

Type	HydrauMind. Closed-centre system with load sensing and pressure compensation valves
Additional circuits	Depending on the specification up to 2 additional proportional control & quick-coupler circuits can be installed
Main pump	Variable displacement piston pump supplying boom, arm, bucket, swing and travel circuits
Maximum pump flow	244 l/min
Relief valve settings	
Implement	380 kg/cm ²
Travel	420 kg/cm ²
Swing	280 kg/cm ²
Pilot circuit	36 kg/cm ²

Swing system

Type	Axial piston motor driving through planetary double reduction gearbox
Swing lock	Electrically actuated wet multi-disc brake integrated into swing motor
Swing speed	0 - 11 rpm
Swing torque	31 kNm

Steering system

Steering control	Hydraulic steering system supplied from a separate gear pump and controlled through LS orbitrol & priority valves
Minimum turning radius	6.450 mm (to center of outer wheel)

Brake system

Type	Dual circuit hydraulic braking system supplied from a separate gear pump
Service brakes	Pedal actuated wet multi-disc brakes integrated into the axle hubs
Parking brake	Electrically actuated wet multi-disc "spring actuation hydraulic release" brake integrated into the transmission

Transmission

Type	Fully automatic power shift transmission with permanent 4 wheel drive
Travel motors	One variable displacement axial piston motor
Maximum pressure	380 bar
Travel modes	Automatic + 3 travel modes
Max. travel speeds	
Hi / Lo / Creep	35.0 / 10.0 / 2.5 km/h
	A max. speed restriction of 20 km/h is available as an option
Maximum drawbar pull	8300 kg
Axle oscillation	10° Lockable in any position from the operator cab

Service refill capacities

Fuel tank	250 l
Radiator	22 l
Engine oil	18 l
Swing drive	2.5 l
Hydraulic tank	169 l
Transmission	3.0 l
Front differential	9.5 l
Rear differential	12.4 l
Front axle hub	2.5 l
Rear axle hub	2.5 l
Swing pinion grease bath amount	10.5 l
AdBlue® tank	57.7 l

Environment

Engine emissions	Fully complies with EU Stage V exhaust emission regulations
Noise levels	
LwA external	101 dB(A) (2000/14/EC Stage II)
LpA operator ear	69 dB(A) (ISO 6396 dynamic test)
Vibration levels (EN 12096:1997)	
Hand/arm	≤ 2.5 m/s ² (uncertainty K = 0.34 m/s ²)
Body	≤ 0.5 m/s ² (uncertainty K = 0.16 m/s ²)
Contains fluorinated greenhouse gas HFC-134a (GWP 1430).	
Quantity of gas 0.9 kg; CO ₂ equivalent 1.29 t	

Operating weight (appr.)

Undercarriage attachment type	Mono boom	Two-piece boom
Without	13865 kg	14105 kg
Rear blade	14595 kg	14830 kg
Rear outrigger	14865 kg	15100 kg
2 outriggers + blade	15595 kg	15830 kg
4 outriggers	15865 kg	16100 kg

Operating weight, including specified work equipment, 2500 mm arm, operator, lubricant, coolant, full fuel tank, bucket (475 kg) and the standard equipment.

Max. bucket capacity and weight

Arm length	Mono boom					
	2100 mm		2500 mm		3000 mm	
Material weight up to 1.2 t/m ³	0.86 m ³	600 kg	0.80 m ³	550 kg	0.68 m ³	500 kg
Material weight up to 1.5 t/m ³	0.73 m ³	525 kg	0.68 m ³	500 kg	0.58 m ³	450 kg
Material weight up to 1.8 t/m ³	0.63 m ³	475 kg	0.50 m ³	450 kg	0.50 m ³	425 kg

Arm length	Two-piece boom					
	2100 mm		2500 mm		3000 mm	
Material weight up to 1.2 t/m ³	0.77 m ³	550 kg	0.71 m ³	525 kg	0.62 m ³	475 kg
Material weight up to 1.5 t/m ³	0.65 m ³	500 kg	0.60 m ³	475 kg	0.53 m ³	425 kg
Material weight up to 1.8 t/m ³	0.57 m ³	450 kg	0.52 m ³	425 kg	0.45 m ³	400 kg

Max. capacity and weight have been calculated according to ISO 10567:2007.

Please consult with your distributor for the correct selection of buckets and attachments to suit the application.

Bucket and arm force

Arm length	2100 mm	2500 mm	3000 mm
Bucket digging force	86 kN	86 kN	86 kN
Bucket digging force at PowerMax	93 kN	93 kN	93 kN
Arm crowd force	74 kN	62 kN	52 kN
Arm crowd force at PowerMax	80 kN	67 kN	56 kN

Dimensions and performance figures

Mono boom

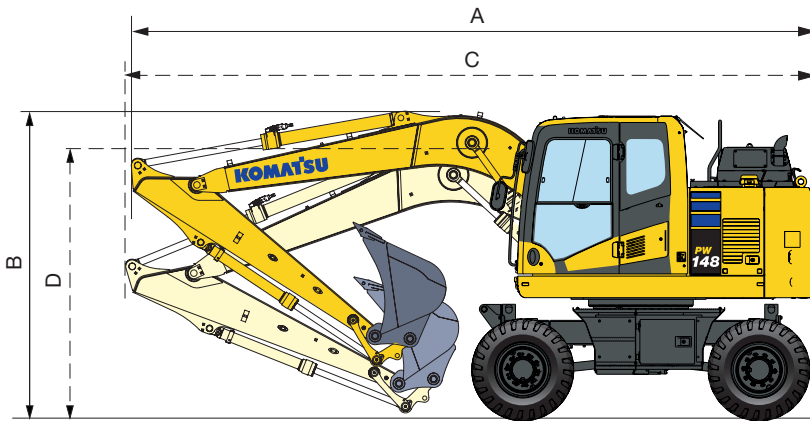

Driving position

Arm length	A	B
2100 mm	7120 mm	3645 mm
2500 mm	7120 mm	3645 mm
3000 mm *	7165 mm	3665 mm

Transport position

Arm length	C	D
2100 mm	7370 mm	2845 mm
2500 mm	7375 mm	2945 mm
3000 mm	7390 mm	3220 mm

* Driving position without bucket

Two-piece boom

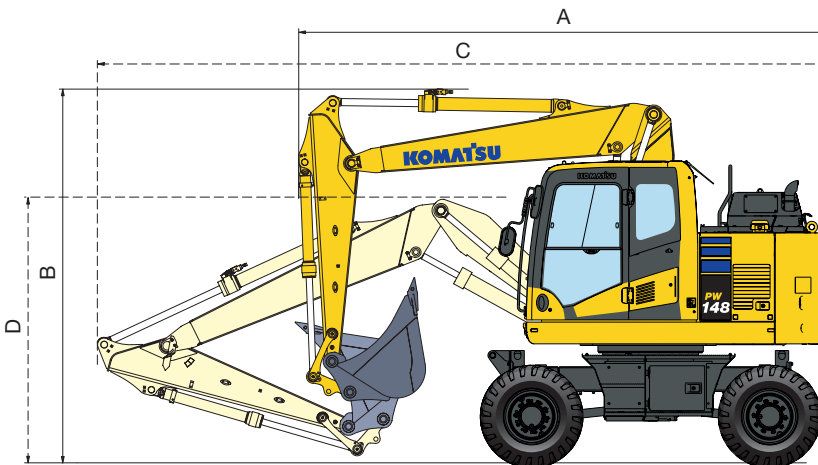

Driving position

Arm length	A	B
2100 mm	5635 mm	3970 mm
2500 mm	5635 mm	3970 mm
3000 mm *	6155 mm	3970 mm

Transport position

Arm length	C	D**
2100 mm	7690 mm	3155 mm
2500 mm	7690 mm	3155 mm
3000 mm	7690 mm	3155 mm

* Driving position without bucket

** Height to top of hose

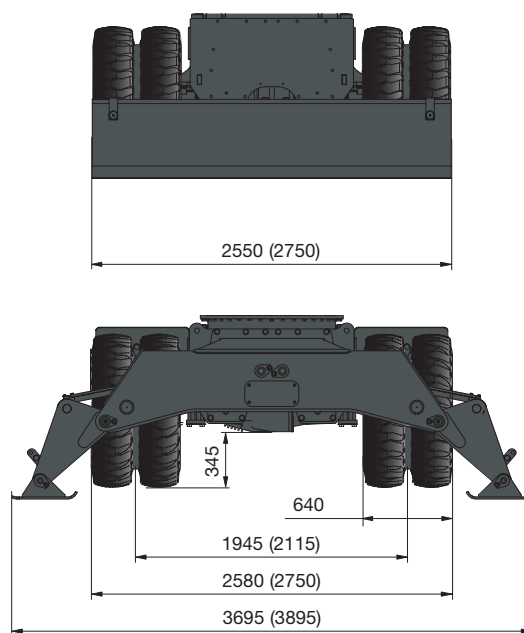
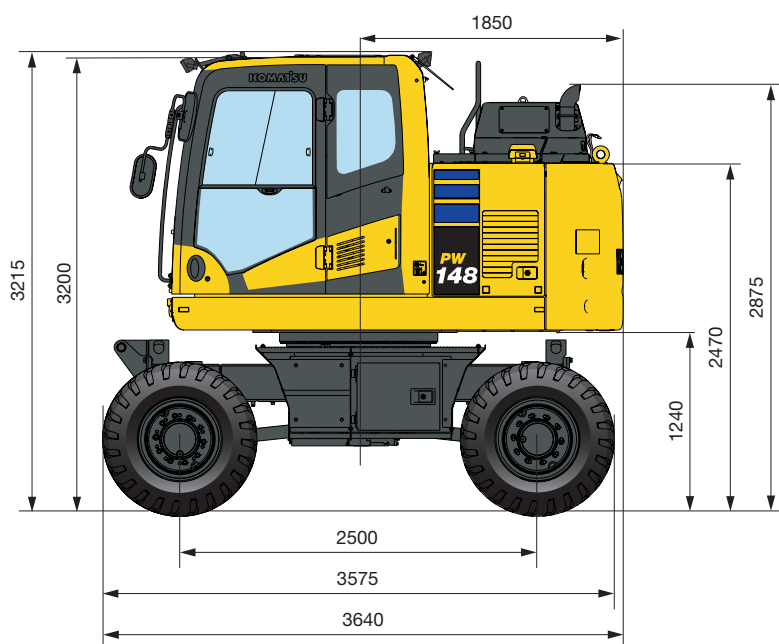

All dimensions with tyres Bandenmarkt Excavator 315/70 R225

(): Figures for 2.75 m undercarriage

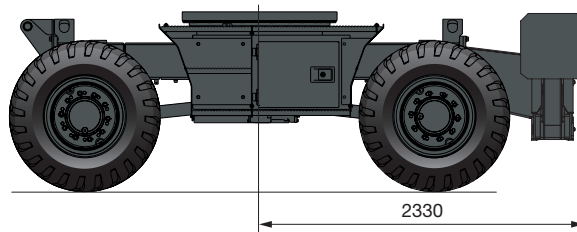
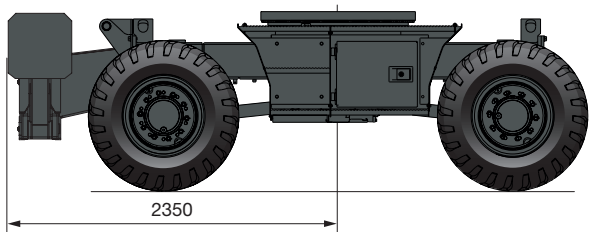
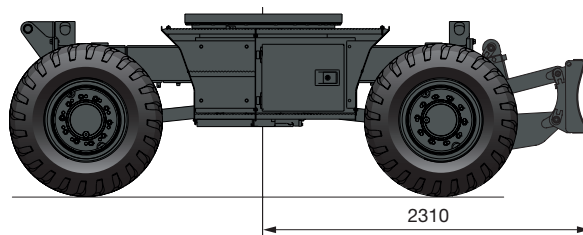
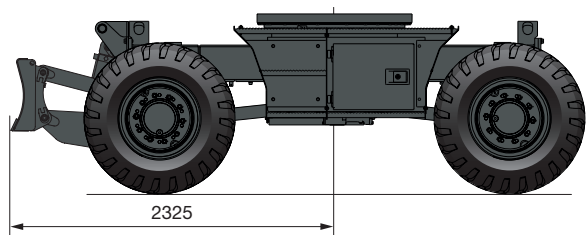

Working range

Mono boom

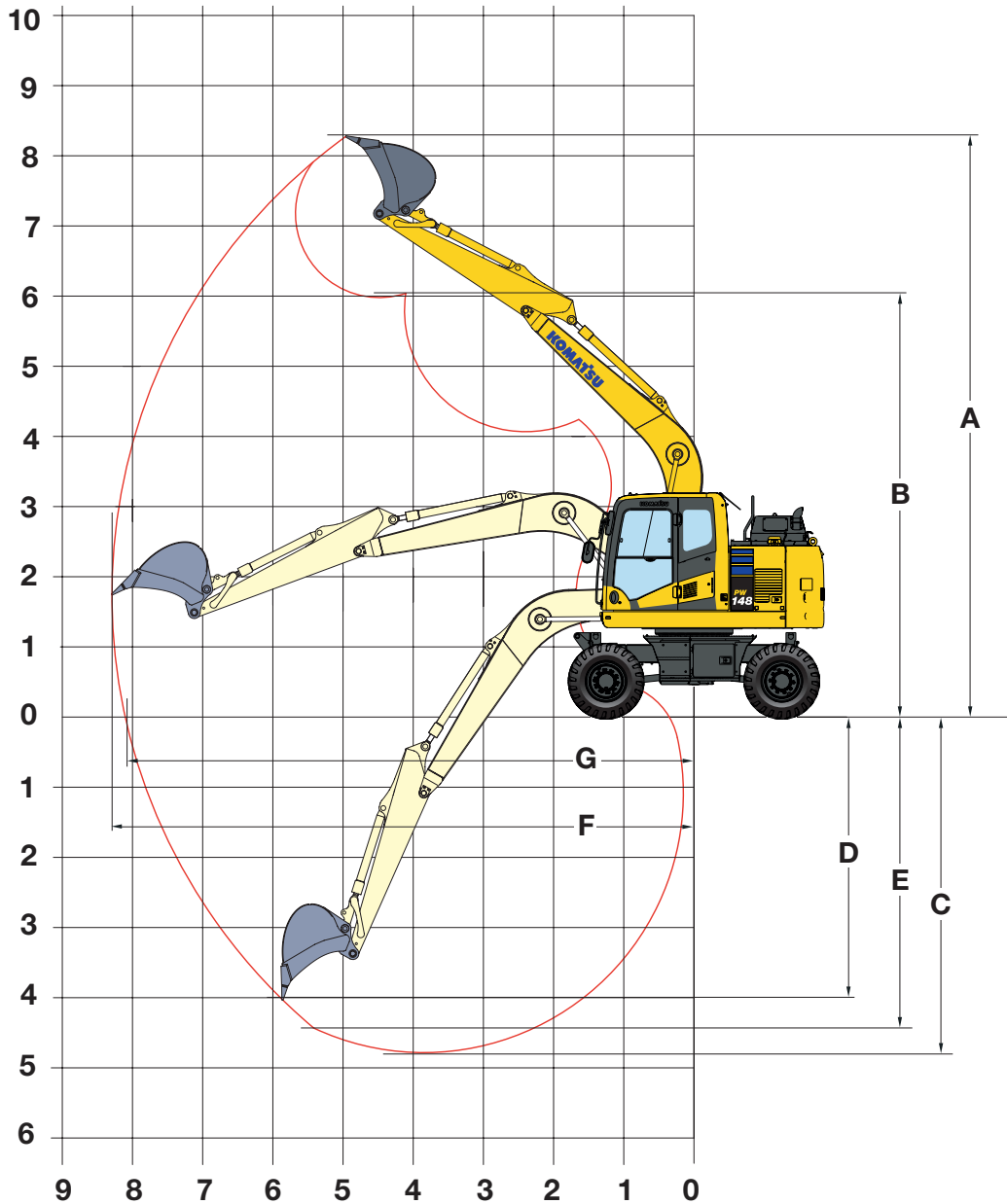

Arm length	2100 mm	2500 mm	3000 mm
A Max digging height	7980 mm	8270 mm	8703 mm
B Max dumping height	5731 mm	6020 mm	6447 mm
C Max digging depth	4462 mm	4860 mm	5362 mm
D Max vertical wall digging depth	3630 mm	4005 mm	4470 mm
E Max digging depth of cut for 2440 mm level	4025 mm	4570 mm	4955 mm
F Max digging reach	7907 mm	8320 mm	8807 mm
G Max digging reach at ground level	7740 mm	8140 mm	8640 mm
Min swing radius	2965 mm	2910 mm	2925 mm

Two-piece boom

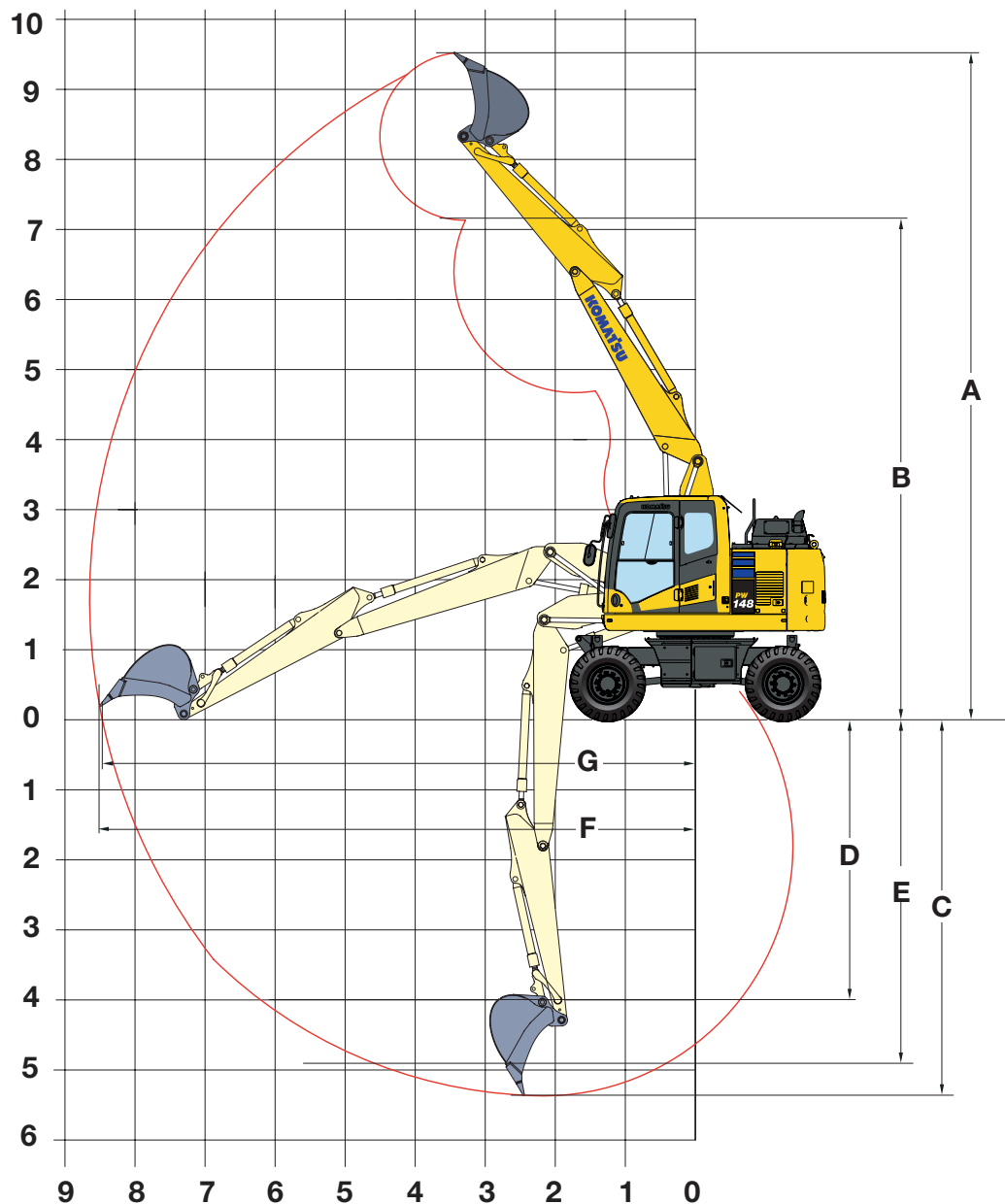

Arm length	2100 mm	2500 mm	3000 mm
A Max digging height	9280 mm	9570 mm	9985 mm
B Max dumping height	6805 mm	7095 mm	7510 mm
C Max digging depth	4885 mm	5285 mm	5785 mm
D Max vertical wall digging depth	3555 mm	4000 mm	4495 mm
E Max digging depth of cut for 2440 mm level	4515 mm	4935 mm	5460 mm
F Max digging reach	8355 mm	8735 mm	9230 mm
G Max digging reach at ground level	8165 mm	8555 mm	9060 mm
Min swing radius	2755 mm	2855 mm	3220 mm

Lifting capacity / mono boom / undercarriage width 2.55 m

Arm length	A	7.5 m		6.0 m		4.5 m		3.0 m		1.5 m	

 Without stabiliser	2100 mm	7.5 m	kg												
		6.0 m	kg	*2850	2400										
		4.5 m	kg	2500	1850	2800		2100	4500	3300					
		3.0 m	kg	2150	1650	2800		2000	4350	3000	8300	5700			
		1.5 m	kg	2100	1500	2700		1950	4050	2950					
		0.0 m	kg	2150	1600	2600		1900	3750	2800	7350	4900			
	2500 mm	-1.5 m	kg	2450	1750	2550		1800	3900	2700	7350	4900	*6350	*6350	
		-3.0 m	kg	3300	2250				3900	2700	*6550	5000			
		7.5 m	kg												
		6.0 m	kg	*2350	2150	*2550		2150							
		4.5 m	kg	*2250	1700	2850		2100							
		3.0 m	kg	2100	1500	2750		2100	4350	3200	*8050	5900			
3000 mm	1.5 m	kg	1950	1400	2550		1950	4100	3000	7800	5200				
	0.0 m	kg	2000	1450	2600		1850	3850	2700	7350	4800				
	-1.5 m	kg	2200	1600	2550		1850	3850	2700	7350	4850	*5750	*5750		
	-3.0 m	kg	2700	2000				3900	2750	7400	4950				
	7.5 m	kg													
	6.0 m	kg	*2300	*2300	2900		2150								

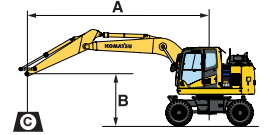



- A – Reach from swing center
- B – Bucket hook height
- C – Lifting capacities, including bucket linkage (84 kg) and bucket cylinder (96 kg)

- Rating over front
- Rating over side
- Rating at maximum reach

When removing linkage or cylinder, lifting capacities can be increased by their respective weights.

* Load is limited by hydraulic capacity rather than tipping. Ratings are based on ISO standard 10567. Rated loads do not exceed 87% of hydraulic lift capacity or 75% of tipping load.

 Front or rear blade	2100 mm	7.5 m	kg												
		6.0 m	kg	*2850	2800										
		4.5 m	kg	*2700	2200	*4050		2500	*5150	3900					
		3.0 m	kg	*2700	1950	*4850		2400	*6050	3700	*8850	6750			
		1.5 m	kg	*2800	1800	*5100		2300	*6800	3450					
		0.0 m	kg	*3150	1900	*5100		2250	*7050	3300	*7700	5900			
	2500 mm	-1.5 m	kg	*3900	2100	*4450		2250	*6400	3250	*9200	5900	*6350	*6350	
		-3.0 m	kg	*3500	2800				*4600	3300	*6550	6000			
		7.5 m	kg												
		6.0 m	kg	*2350	*2400	*2550		2550							
		4.5 m	kg	*2250	2000	*4150		2550							
		3.0 m	kg	*2250	1800	*4700		2450	*5700	3750	*8050	7000			
3000 mm	1.5 m	kg	*2350	1700	*5050		2350	*6650	3500	*10050	6300				
	0.0 m	kg	*2650	1750	*5150		2250	*7050	3300	*8150	5950				
	-1.5 m	kg	*3150	1950	*4750		2200	*6700	3250	*9800	5850	*5750	*5750		
	-3.0 m	kg	*3600	2400				*5250	3300	*7550	6000				
	7.5 m	kg													
	6.0 m	kg	*2000	*2000	*3300		2550								

 Rear outrigger	2100 mm	7.5 m	kg												
		6.0 m	kg	*2850	*2850										
		4.5 m	kg	*2700	*2650	*4050		3150	*5150	5000					
		3.0 m	kg	*2700	2500	*4850		3100	*6050	4800	*8850	*8850			
		1.5 m	kg	*2800	2400	*5100		3000	*6800	4500					
		0.0 m	kg	*3150	2450	*5100		2950	*7050	4350	*7700	*7700			
	2500 mm	-1.5 m	kg	*3900	2750	*4450		2900	*6400	4350	9200	8300	*6350	*6350	
		-3.0 m	kg	*3500	*3500				*4600	4400	*6550	*6550			
		7.5 m	kg												
		6.0 m	kg	*2350	*2350	*2550		*2550							
		4.5 m	kg	*2250	*2250	*4150		3200							
		3.0 m	kg	*2250	*2300	*4700		3150	*5700	4850	*8050	*8050			
3000 mm	1.5 m	kg	*2350	2250	*5050		3000	*6650	4600	*10050	8700				
	0.0 m	kg	*2650	2250	*5150		2950	*7050	4400	*8150	*8150				
	-1.5 m	kg	*3150	2550	*4750		2900	*6700	4350	*9800	8250	*5750	*5750		
	-3.0 m	kg	*3600	3150				*5250	4350	*7550	*7550				
	7.5 m	kg													
	6.0 m	kg	*2000	*2000	*3300		3250								

Arm length	A B	7.5 m		6.0 m		4.5 m		3.0 m		1.5 m	

 Outrigger + blade	2100 mm	7.5 m	kg										
		6.0 m	kg	*2850	*2850								
		4.5 m	kg	*2700	*2700								
		3.0 m	kg	*2700	*2700	*4850	3900	*6050	*6000	*8850	*8850		
		1.5 m	kg	*2800	*2800	*5100	3750	*6800	5800				
		0.0 m	kg	*3150	3100	*5100	3700	*7050	5600	*7700	*7700		
	2500 mm	- 1.5 m	kg	*3900	3450	*4450	3650	*6400	5550	*9200	*9200	*6350	*6350
		- 3.0 m	kg	*3500	*3500			*4600	*4600	*6550	*6550		
		7.5 m	kg										
		6.0 m	kg	*2350	*2350		*2550	*2550					
		4.5 m	kg	*2250	*2250		*4150	4000					
		3.0 m	kg	*2250	*2250		*4700	3900	*5700	*5700	*8050	*8050	
	3000 mm	1.5 m	kg	*2350	*2350		*5050	3800	*6650	5850	*10050	*10050	
		0.0 m	kg	*2650	*2650		*5150	3700	*7050	5650	*8150	*8150	
		- 1.5 m	kg	*3150	*3150		*4750	3650	*6700	5550	*9800	*9800	*5750
- 3.0 m		kg	*3600	*3600				*5250	*5250	*7550	*7550		
7.5 m		kg	*2300	*2300									
6.0 m		kg	*2000	*2000		*3300	*3300						
3000 mm	4.5 m	kg	*1850	*1850		*3950	*3950						
	3.0 m	kg	*1850	*1850	*3050	2700	*4350	3900	*5150	*5150			
	1.5 m	kg	*1950	*1950	*3600	2700	*4750	3750	*6200	5850	*9750	*9750	
	0.0 m	kg	*2100	*2100	*3350	2650	*5050	3600	*6850	5550	*8600	*8600	
	- 1.5 m	kg	*2500	*2500		*4850	3550	*6750	5450	*10250	*10250	*5000	*5000
	- 3.0 m	kg	*3300	*3300		*3850	3600	*5700	5400	*8400	*8400	*8050	*8050

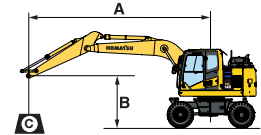

A - Reach from swing center

B - Bucket hook height

C - Lifting capacities, including bucket linkage (84 kg) and bucket cylinder (96 kg)

- Rating over front

- Rating over side



- Rating at maximum reach

When removing linkage or cylinder, lifting capacities can be increased by their respective weights.

* Load is limited by hydraulic capacity rather than tipping. Ratings are based on ISO standard 10567. Rated loads do not exceed 87% of hydraulic lift capacity or 75% of tipping load.

 Outrigger front + rear	2100 mm	7.5 m	kg										
		6.0 m	kg	*2850	*2850								
		4.5 m	kg	*2700	*2700								
		3.0 m	kg	*2700	*2700	*4850	*4850	*6050	*6050	*8850	*8850		
		1.5 m	kg	*2800	*2800	*5100	4800	*6800	*6800				
		0.0 m	kg	*3150	*3150	*5100	4700	*7050	*7050	*7700	*7700		
	2500 mm	- 1.5 m	kg	*3900	*3900	*4450	*4450	*6400	*6400	*9200	*9200	*6350	*6350
		- 3.0 m	kg	*3500	*3500			*4600	*4600	*6550	*6550		
		7.5 m	kg										
		6.0 m	kg	*2350	*2350		*2550	*2550					
		4.5 m	kg	*2250	*2250		*4150	*4150					
		3.0 m	kg	*2250	*2250		*4700	*4700	*5700	*5700	*8050	*8050	
	3000 mm	1.5 m	kg	*2350	*2350		*5050	4800	*6650	*6650	*10050	*10050	
		0.0 m	kg	*2650	*2650		*5150	4700	*7050	*7050	*8150	*8150	
		- 1.5 m	kg	*3150	*3150		*4750	4650	*6700	*6700	*9800	*9800	*5750
- 3.0 m		kg	*3600	*3600				*5250	*5250	*7550	*7550		
7.5 m		kg	*2300	*2300									
6.0 m		kg	*2000	*2000		*3300	*3300						
3000 mm	4.5 m	kg	*1850	*1850		*3950	*3950						
	3.0 m	kg	*1850	*1850	*3050	*3050	*4350	*4350	*5150	*5150			
	1.5 m	kg	*1950	*1950	*3600	3400	*4750	*4750	*6200	*6200	*9750	*9750	
	0.0 m	kg	*2100	*2100	*3350	3300	*5050	4450	*6850	*6850	*8600	*8600	
	- 1.5 m	kg	*2500	*2500		*4850	4550	*6750	*6750	*10250	*10250	*5000	*5000
	- 3.0 m	kg	*3300	*3300		*3850	*3850	*5700	*5700	*8400	*8400	*8050	*8050

Lifting capacity / two-piece boom / undercarriage width 2.55 m

Arm length	A	⊗		7.5 m		6.0 m		4.5 m		3.0 m		1.5 m		
		B	⊗	⊗	⊗	⊗	⊗	⊗	⊗	⊗	⊗	⊗	⊗	
 Without stabiliser	2100 mm	7.5 m	kg	*3550	3300				*3700	3300				
		6.0 m	kg	2850	2100		2850	2100	*4050	3450				
		4.5 m	kg	2250	1650				2800	2100	4500	3300		
		3.0 m	kg	1950	1500			2700	2000	4250	3050			
		1.5 m	kg	1950	1350			2550	1900	4000	2700			
		0.0 m	kg	1950	1450			2550	1800	3850	2700			
	-1.5 m	kg	2200	1600			2550	1800	3800	2650	7250	4800		
	-3.0 m	kg												
	2500 mm	7.5 m	kg	*2850	2750					*3950	3450			
		6.0 m	kg	*2400	1850		2950	2150						
		4.5 m	kg	2100	1500		2900	2100	4350	3350				
		3.0 m	kg	1800	1350	1950	1400	2800	2050	4350	3150			
		1.5 m	kg	1800	1300	1950	1400	2550	1900	4050	2850			
		0.0 m	kg	1800	1350	1900	1350	2550	1800	3600	2700	*5450	4750	
	-1.5 m	kg	2050	1450			2550	1800	3800	2650	7200	4700		
	-3.0 m	kg	2650	1850					3750	2700				
	3000 mm	7.5 m	kg	*2300	2150									
		6.0 m	kg	*2000	1600		2950	2150						
4.5 m		kg	1800	1300	1950	1400	2850	2100	*3850	3400				
3.0 m		kg	1650	1200	1950	1350	2700	2000	4150	3150				
1.5 m		kg	1550	1100	1850	1350	2600	1850	4050	2850				
0.0 m		kg	1600	1150	1800	1250	2400	1700	3750	2600	*5700	4650		
-1.5 m	kg	1700	1200	1800	1250	2300	1700	3650	2550	7000	4550	*3900	*3900	
-3.0 m	kg	2100	1500			2350	1650	3650	2550	7050	4600			
 Front or rear blade	2100 mm	7.5 m	kg	*3550	*3550				*3700	*3650				
		6.0 m	kg	*2900	2450		*3050	2450	*4050	3950				
		4.5 m	kg	*2700	1950		*4100	2450	*5200	3850				
		3.0 m	kg	*2700	1750		*4350	2400	*5850	3600				
		1.5 m	kg	*2750	1650		*4700	2250	*6850	3350				
		0.0 m	kg	*3050	1700		*5050	2200	*6900	3200				
	-1.5 m	kg	*3550	1950		*4450	2150	*6200	3150	*8500	5850			
	-3.0 m	kg												
	2500 mm	7.5 m	kg	*2850	*2850				*3950	*3950				
		6.0 m	kg	*2400	2200		*3750	2550						
		4.5 m	kg	*2300	1800		*4000	2500	*4950	3900				
		3.0 m	kg	*2250	1650	*3350	1700	*4200	2400	*5600	3650			
		1.5 m	kg	*2350	1550	*3600	1650	*4600	2250	*6600	3400			
		0.0 m	kg	*2550	1600	*3350	1650	*5000	2200	*6950	3250	*5450	*5450	
	-1.5 m	kg	*2950	1750			*4700	2150	*6450	3150	*8600	5750		
	-3.0 m	kg	*3400	2250					*5100	3200				
	3000 mm	7.5 m	kg	*2300	*2300									
		6.0 m	kg	*2000	1850		*3700	2550						
4.5 m		kg	*1900	1550	*3000	1650	*3750	2500	*3850	*3850				
3.0 m		kg	*1850	1400	*3250	1650	*4000	2400	*5200	3700				
1.5 m		kg	*1900	1350	*3350	1600	*4300	2250	*6050	3400				
0.0 m		kg	*2050	1350	*3600	1500	*4700	2100	*6800	3150	*5700	5700		
-1.5 m	kg	*2350	1500	*3250	1500	*4750	2050	*6550	3050	*7800	5550	*3900	*3900	
-3.0 m	kg	*2800	1800			*3850	2100	*5550	3050	*7800	5650			
 Rear outrigger	2100 mm	7.5 m	kg	*3550	*3550				*3700	*3700				
		6.0 m	kg	*2900	*2950		*3050	*3000	*4050	*4050				
		4.5 m	kg	*2700	2550		*4100	3150	*5200	4950				
		3.0 m	kg	*2700	2250		*4350	3050	*5850	4700				
		1.5 m	kg	*2750	2200		*4700	2950	*6850	4450				
		0.0 m	kg	*3050	2250		*5050	2850	*6900	4300				
	-1.5 m	kg	*3550	2500		*4450	2850	*6200	4250	*8500	8150			
	-3.0 m	kg												
	2500 mm	7.5 m	kg	*2850	*2850				*3950	*3950				
		6.0 m	kg	*2400	*2400		*3750	3250						
		4.5 m	kg	*2300	*2300		*4000	3200	*4950	*4950				
		3.0 m	kg	*2250	2100	*3350	2200	*4200	3100	*5600	4800			
		1.5 m	kg	*2350	2050	*3600	2150	*4600	3000	*6600	4500			
		0.0 m	kg	*2550	2100	*3350	2100	*5000	2850	*6950	4350	*5450	*5450	
	-1.5 m	kg	*2950	2300			*4700	2850	*6450	4250	*8600	8150		
	-3.0 m	kg	*3400	2950					*5100	4300				
	3000 mm	7.5 m	kg	*2300	*2300									
		6.0 m	kg	*2000	*2000		*3700	3250						
4.5 m		kg	*1900	*1900	*3000	2200	*3750	3200	*3850	*3850				
3.0 m		kg	*1850	*1850	*3250	2150	*4000	3050	*5200	4800				
1.5 m		kg	*1900	1800	*3350	2100	*4300	2950	*6050	4500				
0.0 m		kg	*2050	1800	*3600	2050	*4700	2800	*6800	4200	*5700	*5700		
-1.5 m	kg	*2350	2000	*3250	2050	*4750	2750	*6550	4150	*7800	*7800	*3900	*3900	
-3.0 m	kg	*2800	2400			*3850	2750	*5550	4150	*7800	*7900			

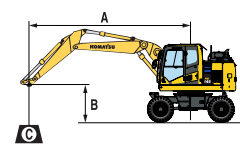

- A – Reach from swing center
- B – Bucket hook height
- C – Lifting capacities, including bucket linkage (84 kg) and bucket cylinder (96 kg)
- ⊗ – Rating at maximum reach
- ⊗ – Rating over front
- ⊗ – Rating over side

When removing linkage or cylinder, lifting capacities can be increased by their respective weights.

* Load is limited by hydraulic capacity rather than tipping. Ratings are based on ISO standard 10567. Rated loads do not exceed 87% of hydraulic lift capacity or 75% of tipping load.

Arm length	A B	7.5 m		6.0 m		4.5 m		3.0 m		1.5 m	

 Outrigger + blade	2100 mm	7.5 m	kg	*3550	*3550			*3700	*3700					
		6.0 m	kg	*2900	*2900			*3050	*3050	*4050	*4050			
		4.5 m	kg	*2700	*2700			*4100	3950	*5200	*5200			
		3.0 m	kg	*2700	*2700			*4350	3850	*5850	*5850			
		1.5 m	kg	*2750	2700			*4700	3750	*6850	5700			
		0.0 m	kg	*3050	2850			*5050	3650	*6900	5550			
	2500 mm	- 1.5 m	kg	*3550	3150			*4450	3600	*6200	5500	*8500	*8500	
		- 3.0 m	kg											
		7.5 m	kg	*2850	*2850					*3950	*3950			
		6.0 m	kg	*2400	*2400			*3750	*3750					
		4.5 m	kg	*2300	*2300			*4000	*4000	*4950	*4950			
		3.0 m	kg	*2250	*2250	*3350	2650	*4200	3900	*5600	*5600			
	3000 mm	1.5 m	kg	*2350	*2350	*3600	2700	*4600	3750	*6600	5750			
		0.0 m	kg	*2550	*2550	*3350	2700	*5000	3650	*6950	5550	*5450	*5450	
		- 1.5 m	kg	*2950	2900			*4700	3600	*6450	5500	*8600	*8600	
- 3.0 m		kg	*3400	*3400					*5100	*5050				
7.5 m		kg	*2300	*2300										
6.0 m		kg	*2000	*2000			*3700	*3700						
	4.5 m	kg	*1900	*1900	*3000	2700	*3750	*3750	*3850	*3850				
	3.0 m	kg	*1850	*1850	*3250	2700	*4000	3850	*5200	*5200				
	1.5 m	kg	*1900	*1900	*3350	2650	*4300	3700	*6050	5750				
	0.0 m	kg	*2050	*2050	*3600	2600	*4700	3600	*6800	5500	*5700	*5700		
	- 1.5 m	kg	*2350	*2350	*3250	2550	*4750	3500	*6550	5400	*7800	*7800	*3900	*3900
	- 3.0 m	kg	*2800	*2800			*3850	3550	*5550	5400	*7800	*7800		

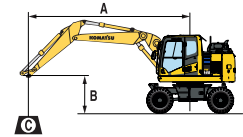

A - Reach from swing center

B - Bucket hook height

C - Lifting capacities, including bucket linkage (84 kg) and bucket cylinder (96 kg)

- Rating over front

- Rating over side

- Rating at maximum reach

When removing linkage or cylinder, lifting capacities can be increased by their respective weights.

* Load is limited by hydraulic capacity rather than tipping. Ratings are based on ISO standard 10567. Rated loads do not exceed 87% of hydraulic lift capacity or 75% of tipping load.

 Outrigger front + rear	2100 mm	7.5 m	kg	*3550	*3550			*3700	*3700					
		6.0 m	kg	*2900	*2900			*3050	*3050	*4050	*4050			
		4.5 m	kg	*2700	*2700			*4100	*4100	*5200	*5200			
		3.0 m	kg	*2700	*2700			*4350	*4350	*5850	*5850			
		1.5 m	kg	*2750	*2750			*4700	*4700	*6850	*6850			
		0.0 m	kg	*3050	*3050			*5050	4350	*6900	*6900			
	2500 mm	- 1.5 m	kg	*3550	*3550			*4450	*4450	*6200	*6200	*8500	*8500	
		- 3.0 m	kg											
		7.5 m	kg	*2850	*2850					*3950	*3950			
		6.0 m	kg	*2400	*2400			*3750	*3750					
		4.5 m	kg	*2300	*2300			*4000	*4000	*4950	*4950			
		3.0 m	kg	*2250	*2250	*3350	*3350	*4200	*4200	*5600	*5600			
	3000 mm	1.5 m	kg	*2350	*2350	*3600	3300	*4600	*4600	*6600	*6600			
		0.0 m	kg	*2550	*2550	*3350	*3350	*5000	4650	*6950	*6950	*5450	*5450	
		- 1.5 m	kg	*2950	*2950			*4700	4650	*6450	*6450	*8600	*8600	
- 3.0 m		kg	*3400	*3400					*5100	*5100				
7.5 m		kg	*2300	*2300										
6.0 m		kg	*2000	*2000			*3700	*3700						
	4.5 m	kg	*1900	*1900	*3000	*3000	*3750	*3750	*3850	*3850				
	3.0 m	kg	*1850	*1850	*3250	*3250	*4000	*4000	*5200	*5200				
	1.5 m	kg	*1900	*1900	*3350	3150	*4300	*4300	*6050	*6050				
	0.0 m	kg	*2050	*2050	*3600	3050	*4700	4600	*6800	*6800	*5700	*5700		
	- 1.5 m	kg	*2350	*2350	*3250	3050	*4750	4250	*6550	*6550	*7800	*7800	*3900	*3900
	- 3.0 m	kg	*2800	*2800			*3850	*3850	*5550	*5550	*7800	*7800		

Lifting capacity / mono boom / undercarriage width 2.75 m

Arm length	A	⊗		7.5 m		6.0 m		4.5 m		3.0 m		1.5 m	
		⊗	⊗	⊗	⊗	⊗	⊗	⊗	⊗	⊗	⊗	⊗	⊗

 <p>Without stabiliser</p>	2100 mm	7.5 m	kg											
		6.0 m	kg	*2850	2700									
		4.5 m	kg	2550	2100			2900	2400	4650	3750			
		3.0 m	kg	2250	1850			2850	2350	4400	3550	8450	6600	
		1.5 m	kg	2150	1800			2750	2250	4150	3300			
		0.0 m	kg	2250	1800			2700	2150	4000	3150	7500	5700	
	2500 mm	-1.5 m	kg	2550	2050			2650	2150	3950	3150	7500	5700	*6350 *6350
		-3.0 m	kg	3300	2700					4000	3200	*6550	5850	
		7.5 m	kg											
		6.0 m	kg	*2350	*2350			*2550	2450					
		4.5 m	kg	*2250	1950			3000	2450					
		3.0 m	kg	2100	1700			2850	2350	4500	3600	*8050	6750	
3000 mm	1.5 m	kg	2000	1650			2750	2250	4200	3400	7950	6050		
	0.0 m	kg	2100	1650			2700	2150	4050	3200	7550	5700		
	-1.5 m	kg	2300	1850			2650	2100	3900	3150	7450	5700	*5750 *5750	
	-3.0 m	kg	2900	2350					3950	3150	7550	5750		
	7.5 m	kg	*2300	*2300										
	6.0 m	kg	*2000	*2000			3000	2450						

 <p>Front or rear blade</p>	2100 mm	7.5 m	kg											
		6.0 m	kg	*2850	*2900									
		4.5 m	kg	*2700	2450			*4050	2800	*5150	4350			
		3.0 m	kg	*2700	2150			*4850	2700	*6050	4150	*8850	7850	
		1.5 m	kg	*2800	2100			*5100	2600	*6800	3900			
		0.0 m	kg	*3150	2100			*5100	2550	*7050	3750	*7700	6900	
	2500 mm	-1.5 m	kg	*3900	2400			*4450	2550	*6400	3750	*9200	6900	*6350 *6350
		-3.0 m	kg	*3500	3150					*4600	3750	*6550	*6550	
		7.5 m	kg											
		6.0 m	kg	*2350	*2350			*2550	*2550					
		4.5 m	kg	*2250	*2250			*4150	2850					
		3.0 m	kg	*2250	2000			*4700	2750	*5700	4200	*8050	8000	
3000 mm	1.5 m	kg	*2350	1950			*5050	2650	*6650	3950	*10050	7250		
	0.0 m	kg	*2650	1950			*5150	2550	*7050	3750	*8150	6900		
	-1.5 m	kg	*3150	2200			*4750	2500	*6700	3700	*9800	6900	*5750 *5750	
	-3.0 m	kg	*3600	2750					*5250	3750	*7550	6950		
	7.5 m	kg	*2300	*2300										
	6.0 m	kg	*2000	*2000			*3300	2850						

 <p>Rear outrigger</p>	2100 mm	7.5 m	kg											
		6.0 m	kg	*2850	*2850									
		4.5 m	kg	*2700	*2650			*4050	3450	*5150	*5150			
		3.0 m	kg	*2700	*2650			*4850	3400	*6050	5250	*8850	*8850	
		1.5 m	kg	*2800	2600			*5100	3300	*6800	5000			
		0.0 m	kg	*3150	2700			*5100	3200	*7050	4850	*7700	*7700	
	2500 mm	-1.5 m	kg	*3900	3050			*4450	3200	*6400	4800	*9200	*9200	*6350 *6350
		-3.0 m	kg	*3500	*3500					*4600	*4600	*6550	*6550	
		7.5 m	kg											
		6.0 m	kg	*2350	*2350			*2550	*2550					
		4.5 m	kg	*2250	*2250			*4150	3550					
		3.0 m	kg	*2250	*2300			*4700	3450	*5700	5350	*8050	*8050	
3000 mm	1.5 m	kg	*2350	*2350			*5050	3300	*6650	5100	*10050	9800		
	0.0 m	kg	*2650	2500			*5150	3250	*7050	4900	*8150	*8150		
	-1.5 m	kg	*3150	2750			*4750	3200	*6700	4800	*9800	9350	*5750 *5750	
	-3.0 m	kg	*3600	3500					*5250	4800	*7550	*7550		
	7.5 m	kg	*2300	*2300										
	6.0 m	kg	*2000	*2000			*3300	*3300						

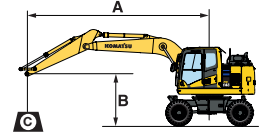

A – Reach from swing center

B – Bucket hook height

C – Lifting capacities, including bucket linkage (84 kg) and bucket cylinder (96 kg)

⊗ – Rating over rear/front



⊗ – Rating over side

⊗ – Rating at maximum reach

When removing linkage or cylinder, lifting capacities can be increased by their respective weights.

* Load is limited by hydraulic capacity rather than tipping. Ratings are based on ISO standard 10567. Rated loads do not exceed 87% of hydraulic lift capacity or 75% of tipping load.

Arm length	A B	7.5 m		6.0 m		4.5 m		3.0 m		1.5 m	

 Outrigger + blade	2100 mm	7.5 m	kg										
		6.0 m	kg	*2850	*2850								
		4.5 m	kg	*2700	*2700								
		3.0 m	kg	*2700	*2700								
		1.5 m	kg	*2800	*2800								
		0.0 m	kg	*3150	*3150								
	2500 mm	-1.5 m	kg	*3900	3850								
		-3.0 m	kg	*3500	*3500								
		7.5 m	kg										
		6.0 m	kg	*2350	*2350								
		4.5 m	kg	*2250	*2250								
		3.0 m	kg	*2250	*2250								
3000 mm	1.5 m	kg	*2350	*2350									
	0.0 m	kg	*2650	*2650									
	-1.5 m	kg	*3150	*3150									
	-3.0 m	kg	*3600	*3600									
	7.5 m	kg	*2300	*2300									
	6.0 m	kg	*2000	*2000									
 Outrigger front + rear	2100 mm	4.5 m	kg										
		3.0 m	kg	*2700	*2700								
		1.5 m	kg	*2800	*2800								
		0.0 m	kg	*3150	*3150								
		-1.5 m	kg	*3900	*3900								
		-3.0 m	kg	*3500	*3500								
	2500 mm	7.5 m	kg										
		6.0 m	kg	*2350	*2350								
		4.5 m	kg	*2250	*2250								
		3.0 m	kg	*2250	*2250								
		1.5 m	kg	*2350	*2350								
		0.0 m	kg	*2650	*2650								
3000 mm	-1.5 m	kg	*3150	*3150									
	-3.0 m	kg	*3600	*3600									
	7.5 m	kg	*2300	*2300									
	6.0 m	kg	*2000	*2000									
	4.5 m	kg	*1850	*1850									
	3.0 m	kg	*1850	*1850									

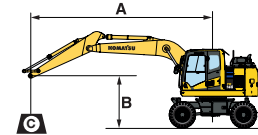

A - Reach from swing center

B - Bucket hook height

C - Lifting capacities, including bucket linkage (84 kg) and bucket cylinder (96 kg)

- Rating over rear/front



- Rating over side

- Rating at maximum reach

When removing linkage or cylinder, lifting capacities can be increased by their respective weights.

* Load is limited by hydraulic capacity rather than tipping. Ratings are based on ISO standard 10567. Rated loads do not exceed 87% of hydraulic lift capacity or 75% of tipping load.

Lifting capacity / two-piece boom / undercarriage width 2.75 m

Arm length	A	⊗		7.5 m		6.0 m		4.5 m		3.0 m		1.5 m		
		B	⊗	⊗	⊗	⊗	⊗	⊗	⊗	⊗	⊗	⊗	⊗	
 Without stabiliser	2100 mm	7.5 m kg	*3550	*3550					*3750	*3750				
		6.0 m kg	*2900	2400		3000	2400	*4050	3900					
		4.5 m kg	2400	1950		3000	2450	4650	3800					
		3.0 m kg	2100	1700		2850	2350	4450	3600					
		1.5 m kg	2050	1650		2800	2250	4200	3300					
		0.0 m kg	2100	1700		2700	2150	4050	3150					
	-1.5 m kg	2350	1900		2700	2150	4000	3150	7650	5750				
	-3.0 m kg													
	2500 mm	7.5 m kg	*2850	*2850					*3950	*3950				
		6.0 m kg	*2400	2150		3050	2500							
		4.5 m kg	2200	1800		3000	2500	4750	3900					
		3.0 m kg	1950	1600	2100	1650	2900	2400	4500	3650				
1.5 m kg		1900	1550	2000	1650	2800	2250	4200	3350					
0.0 m kg		1950	1550	1900	1600	2700	2150	4050	3200	*5400	*5400			
-1.5 m kg	2150	1750			2650	2100	3950	3150	7550	5700				
-3.0 m kg	2750	2250					4000	3150						
3000 mm	7.5 m kg	*2300	*2300											
	6.0 m kg	*2000	1850		3050	2500								
	4.5 m kg	1900	1500	2050	1650	3000	2450	*3850	*3850					
	3.0 m kg	1750	1350	2000	1650	2850	2350	4500	3650					
	1.5 m kg	1650	1350	1950	1550	2750	2200	4200	3350					
	0.0 m kg	1700	1350	1900	1500	2600	2100	3950	3150	*5700	5600			
-1.5 m kg	1850	1500	1900	1500	2550	2050	3850	3000	7350	5550	*3900	*3900		
-3.0 m kg	2200	1800			2550	2050	3850	3000	7400	5550				
 Front or rear blade	2100 mm	7.5 m kg	*3550	*3550					*3750	*3750				
		6.0 m kg	*2900	2800		*3100	2850	*4050	*4000					
		4.5 m kg	*2700	2250		*4150	2850	*5250	4400					
		3.0 m kg	*2700	2000		*4400	2700	*5900	4200					
		1.5 m kg	*2750	1950		*4750	2650	*6850	3900					
		0.0 m kg	*3050	2000		*5050	2550	*6900	3750					
	-1.5 m kg	*3550	2250		*4450	2550	*6200	3750	*8500	6950				
	-3.0 m kg													
	2500 mm	7.5 m kg	*2850	*2850					*3950	*3950				
		6.0 m kg	*2400	*2400		*3750	2900							
		4.5 m kg	*2300	2100		*4050	2850	*5000	4500					
		3.0 m kg	*2250	1900	*3350	1950	*4250	2750	*5650	4250				
1.5 m kg		*2350	1800	*3650	1950	*4600	2650	*6650	3950					
0.0 m kg		*2550	1850	*3400	1900	*5050	2550	*6950	3750	*5400	*5400			
-1.5 m kg	*2950	2050			*4700	2550	*6450	3750	*8500	6900				
-3.0 m kg	*3400	2600					*5050	3750						
3000 mm	7.5 m kg	*2300	*2300											
	6.0 m kg	*2000	*2000		*3700	2900								
	4.5 m kg	*1900	1800	*3000	1950	*3800	2850	*3850	*3850					
	3.0 m kg	*1850	1650	*3250	1950	*4000	2700	*5250	4250					
	1.5 m kg	*1900	1600	*3400	1850	*4350	2600	*6150	3900					
	0.0 m kg	*2050	1600	*3650	1800	*4750	2450	*6800	3700	*5700	*5650			
-1.5 m kg	*2350	1750	*3300	1800	*4750	2400	*6550	3600	*7700	6700	*3900	*3900		
-3.0 m kg	*2800	2100			*3850	2400	*5500	3600	*7800	6750				
 Rear outrigger	2100 mm	7.5 m kg	*3550	*3550					*3750	*3750				
		6.0 m kg	*2900	*2950		*3100	*3100	*4050	*4050					
		4.5 m kg	*2700	*2700		*4150	3550	*5250	*5250					
		3.0 m kg	*2700	2550		*4400	3450	*5900	5300					
		1.5 m kg	*2750	2450		*4750	3300	*6850	5000					
		0.0 m kg	*3050	2550		*5050	3250	*6900	4850					
	-1.5 m kg	*3550	2850		*4450	3200	*6200	4800	*8500	*8500				
	-3.0 m kg													
	2500 mm	7.5 m kg	*2850	*2850					*3950	*3950				
		6.0 m kg	*2400	*2400		*3750	3600							
		4.5 m kg	*2300	*2300		*4050	3600	*5000	*5000					
		3.0 m kg	*2250	*2250	*3350	2450	*4250	3450	*5650	5400				
1.5 m kg		*2350	2250	*3650	2400	*4600	3350	*6650	5100					
0.0 m kg		*2550	2350	*3400	2400	*5050	3250	*6950	4900	*5400	*5400			
-1.5 m kg	*2950	2550			*4700	3200	*6450	4800	*8500	*8500				
-3.0 m kg	*3400	3300					*5050	4850						
3000 mm	7.5 m kg	*2300	*2300											
	6.0 m kg	*2000	*2000		*3700	3600								
	4.5 m kg	*1900	*1900	*3000	2450	*3800	3550	*3850	*3850					
	3.0 m kg	*1850	*1850	*3250	2400	*4000	3450	*5250	*5250					
	1.5 m kg	*1900	*1950	*3400	2350	*4350	3300	*6150	5050					
	0.0 m kg	*2050	2050	*3650	2300	*4750	3150	*6800	4800	*5700	*5700			
-1.5 m kg	*2350	2250	*3300	2250	*4750	3100	*6550	4700	*7700	*7700	*3900	*3900		
-3.0 m kg	*2800	2700			*3850	3100	*5500	4700	*7800	*7800				

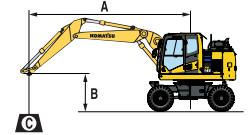

- A - Reach from swing center
- B - Bucket hook height
- C - Lifting capacities, including bucket linkage (84 kg) and bucket cylinder (96 kg)
- ⊗ - Rating at maximum reach
- ⊗ - Rating over rear/front
- ⊗ - Rating over side

When removing linkage or cylinder, lifting capacities can be increased by their respective weights.

* Load is limited by hydraulic capacity rather than tipping. Ratings are based on ISO standard 10567. Rated loads do not exceed 87% of hydraulic lift capacity or 75% of tipping load.

Arm length	A B	⊗		7.5 m		6.0 m		4.5 m		3.0 m		1.5 m	
		⊗	⊗	⊗	⊗	⊗	⊗	⊗	⊗	⊗	⊗	⊗	⊗

 <p>Outrigger + blade</p>	2100 mm	7.5 m kg	*3550	*3550					*3750	*3750				
		6.0 m kg	*2900	*2900			*3100	*3100	*4050	*4050				
		4.5 m kg	*2700	*2700			*4150	*4150	*5250	*5250				
		3.0 m kg	*2700	*2700			*4400	4300	*5900	*5900				
		1.5 m kg	*2750	*2750			*4750	4200	*6850	6450				
		0.0 m kg	*3050	*3050			*5050	4050	*6900	6300				
	- 1.5 m kg	*3550	3550			*4450	4050	*6200	*6200	*8500	*8500			
	- 3.0 m kg													
	2500 mm	7.5 m kg	*2850	*2850					*3950	*3950				
		6.0 m kg	*2400	*2400			*3750	*3750						
		4.5 m kg	*2300	*2300			*4050	*4050	*5000	*5000				
		3.0 m kg	*2250	*2250	*3350	3050	*4250	*4250	*5650	*5650				
1.5 m kg		*2350	*2350	*3650	3000	*4600	4200	*6650	6500					
0.0 m kg		*2550	*2550	*3400	3000	*5050	4100	*6950	6300	*5400	*5400			
- 1.5 m kg	*2950	*2950			*4700	4050	*6450	6200	*8500	*8500				
- 3.0 m kg	*3400	*3400					*5050	*5050						
3000 mm	7.5 m kg	*2300	*2300											
	6.0 m kg	*2000	*2000			*3700	*3700							
	4.5 m kg	*1900	*1900	*3000	*3000	*3800	*3800	*3850	*3850					
	3.0 m kg	*1850	*1850	*3250	3000	*4000	*4000	*5250	*5250					
	1.5 m kg	*1900	*1900	*3400	3000	*4350	4150	*6150	*6150					
	0.0 m kg	*2050	*2050	*3650	2900	*4750	4050	*6800	6200	*5700	*5700			
	- 1.5 m kg	*2350	*2350	*3300	2900	*4750	3950	*6550	6100	*7700	*7700	*3900	*3900	
	- 3.0 m kg	*2800	*2800			*3850	*3850	*5500	*5500	*7800	*7800			

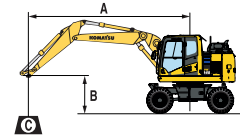

A - Reach from swing center

B - Bucket hook height

C - Lifting capacities, including bucket linkage (84 kg) and bucket cylinder (96 kg)

⊗ - Rating over rear/front

⊗ - Rating over side

⊗ - Rating at maximum reach

When removing linkage or cylinder, lifting capacities can be increased by their respective weights.

* Load is limited by hydraulic capacity rather than tipping. Ratings are based on ISO standard 10567. Rated loads do not exceed 87% of hydraulic lift capacity or 75% of tipping load.

 <p>Outrigger front + rear</p>	2100 mm	7.5 m kg	*3550	*3550					*3750	*3750				
		6.0 m kg	*2900	*2900			*3100	*3100	*4050	*4050				
		4.5 m kg	*2700	*2700			*4150	*4150	*5250	*5250				
		3.0 m kg	*2700	*2700			*4400	*4400	*5900	*5900				
		1.5 m kg	*2750	*2750			*4750	*4750	*6850	*6850				
		0.0 m kg	*3050	*3050			*5050	*5050	*6900	*6900				
	- 1.5 m kg	*3550	*3550			*4450	*4450	*6200	*6200	*8500	*8500			
	- 3.0 m kg													
	2500 mm	7.5 m kg	*2850	*2850					*3950	*3950				
		6.0 m kg	*2400	*2400			*3750	*3750						
		4.5 m kg	*2300	*2300			*4050	*4050	*5000	*5000				
		3.0 m kg	*2250	*2250	*3350	*3350	*4250	*4250	*5650	*5650				
1.5 m kg		*2350	*2350	*3650	*3650	*4600	*4600	*6650	*6650					
0.0 m kg		*2550	*2550	*3400	*3400	*5050	*5050	*6950	*6950	*5400	*5400			
- 1.5 m kg	*2950	*2950			*4700	*4700	*6450	*6450	*8500	*8500				
- 3.0 m kg	*3400	*3400					*5050	*5050						
3000 mm	7.5 m kg	*2300	*2300											
	6.0 m kg	*2000	*2000			*3700	*3700							
	4.5 m kg	*1900	*1900	*3000	*3000	*3800	*3800	*3850	*3850					
	3.0 m kg	*1850	*1850	*3250	*3250	*4000	*4000	*5250	*5250					
	1.5 m kg	*1900	*1900	*3400	*3400	*4350	*4350	*6150	*6150					
	0.0 m kg	*2050	*2050	*3650	3600	*4750	*4750	*6800	*6800	*5700	*5700			
	- 1.5 m kg	*2350	*2350	*3300	*3300	*4750	*4750	*6550	*6550	*7700	*7700	*3900	*3900	
	- 3.0 m kg	*2800	*2800			*3850	*3850	*5500	*5500	*7800	*7800			

Standard and optional equipment

Engine

Komatsu SAA4D107E-5 turbocharged common rail direct injection diesel engine	●
EU Stage V compliant	●
Suction type cooling fan	●
Automatic engine warm-up system	●
Engine overheat prevention system	●
Auto-deceleration function	●
Adjustable idle shutdown	●
Engine ignition can be password secured on request	●
Batteries 2 × 12 V/125 Ah	●
Alternator 24 V / 85 A	●
Starter motor 24 V / 4.5 kW	●

Hydraulic system

Electronic closed-centre load sensing (E-CLSS) hydraulic system (HydraMind)	●
Pump and engine mutual control (PEMC) system	●
6-working mode selection system; Power, Lifting/Fine Operation, Breaker, Economy, Attachment Power and Attachment Economy	●
PowerMax function	●
Adjustable PPC wrist control levers for arm, boom, bucket and swing, with sliding proportional control for attachments and 5 auxiliary buttons, with FNR switch	●
Additional hydraulic circuit (HCU-B)	●
Additional hydraulic circuit (HCU-C)	○
Extension HCU-C to HCU-D	○
Komatsu Integrated Attachment Control (KIAC)	○
Boom suspension system (ECSS)	○
Prepared for hydraulic quick-coupler	○

Undercarriage

Parallel blade (front and/or rear) with cylinder protection	○
2 or 4 outriggers with cylinder protection, individually adjustable	○
Limited-slip differential (LSD)	○
Twin tyres 10.00-20 16 PR	○
Twin tyres Bandenmarkt Excavator 315/70 R22.5	○
Twin tyres Nokian 10-20 (L5)	○
Single tyres Michelin 18.00-19.5	○
Tyres Bandenmarkt Grader 315/70 R22.5	○
Trailer hitches	○
Fenders	○

Cabin

SpaceCab™; ROPS, highly pressurised and tightly sealed hyper viscous mounted cab with tinted safety glass windows, large roof window with sun shade, pull-up type front window with locking device, removable lower window, front window wiper with intermittent feature, sun roller blind, cigarette lighter, luggage shelf, floor mat	●
Heated air suspension seat with lumbar support, arm rests and retractable seat belt	●
Automatic climate control system	●
12/24 Volt power supplies	●
Beverage holder and magazine rack	●
Hot and cool box	●
Adjustable steering column	●
Premium comfort seat	○
DAB+ radio with Bluetooth®, USB, AUX and hands-free kit	○
Heated, adjustable, suspended seat	○
Lower wiper	○
Rain visor (not with OPG)	○
Joystick steering system	○

Safety equipment

KomVision surround view system	●
Electric horn	●
Overload warning device	●
Lockable fuel cap and covers	●
Audible travel alarm	●
Large handrails, rear-view mirrors	●
Battery main switch	●
Boom safety valves	●
Arm safety valve	●
Adjust cylinder safety valve	●
OPG Level II front guard (FOPS)	○
OPG Level II top guard (FOPS)	○
Audible travel alarm (white noise version)	○

Lighting system

Standard halogen working lights package	●
LED working lights package	○
Advanced LED working lights package	○
Beacon	○

Service and maintenance

Automatic fuel line de-aeration	●
Double element type air cleaner with dust indicator and auto dust evacuator	●
Komtrax – Komatsu wireless monitoring system (4G)	●
Multifunction video compatible colour monitor with Equipment Management and Monitoring System (EMMS) and efficiency guidance	●
Toolkit	●
Komatsu Care – a maintenance program for Komatsu customers	●
Remote greasing bar	●
Automatic greasing system	○

Drives and brakes

Fully automatic 3-speed transmission driving through front and rear planetary axles	●
Oscillating front axle (10°) with automatic and manual cylinder locking	●
Cruise control	●
2.55 m wide undercarriage	●
2.75 m wide undercarriage	○
20, 25 or 35 km/h speed limitation	○
Transmission guard	○
Automatic digging brake	○

Work equipment

Mono boom	○
Two-piece boom	○
2100 mm; 2500 mm; 3000 mm arms	○
Clamshell grip bar	○
Lehnhoff quick-couplers	○
Lehnhoff buckets	○

Other equipment

Standard counterweight	●
Electric refuelling pump with automatic shut-off function	●
Single chassis tool box	●
Additional chassis tool box	○
Biodegradable oil for hydraulic system	○
Customised paint	○
License plate holder	○

Further equipment on request

- standard equipment
- optional equipment

This specification sheet may contain attachments and optional equipment that are not available in your area. Please consult your local Komatsu distributor for those items you may require. Materials and specifications are subject to change without notice.

Your Komatsu partner:

KOMATSU

[komatsu.eu](https://www.komatsu.eu)

